

Multi II - Instruction for use



107417216 c (10.2017)
EN-DE-FR-NL-IT-NO-SV-DA-FI-ES-PT-EL-TR-SL-
HR-SK-CS-PL-HU-RO-BG-RU-ET-LV-LT-JA-AR

 **Nilfisk®**



Nilfisk

Multi II





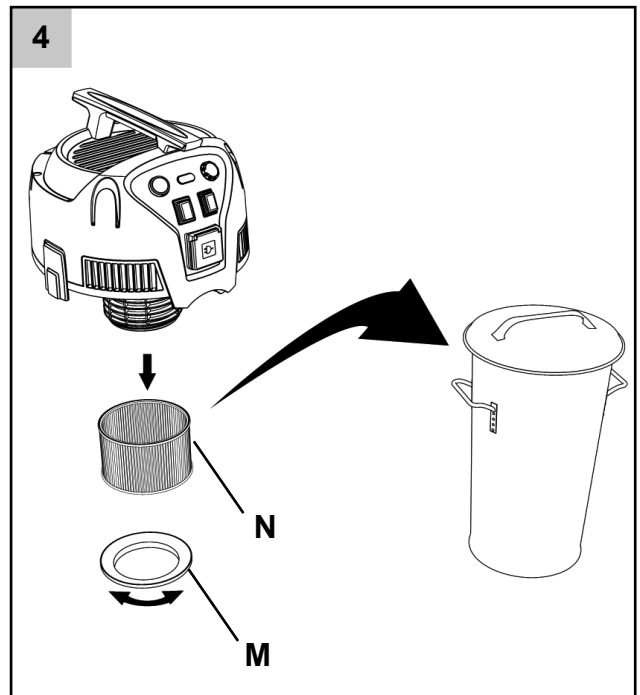
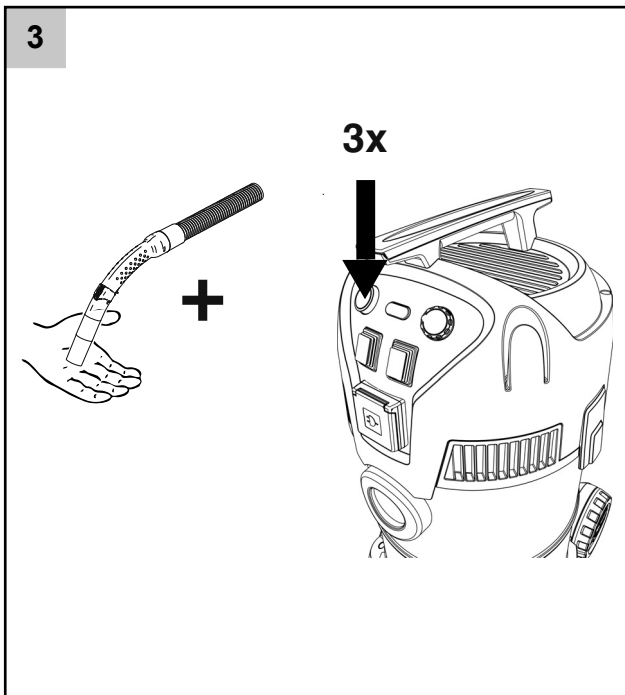
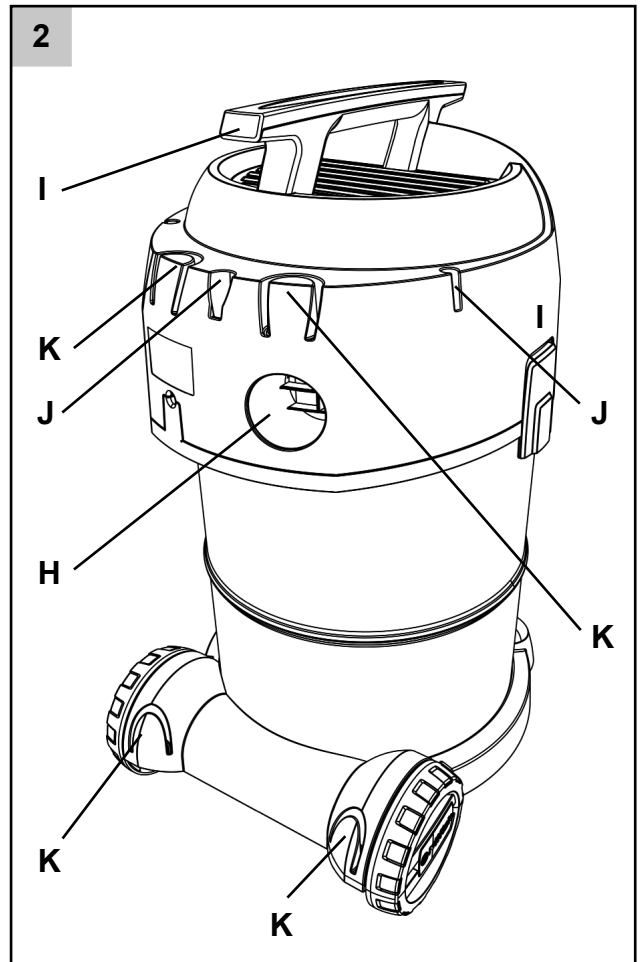
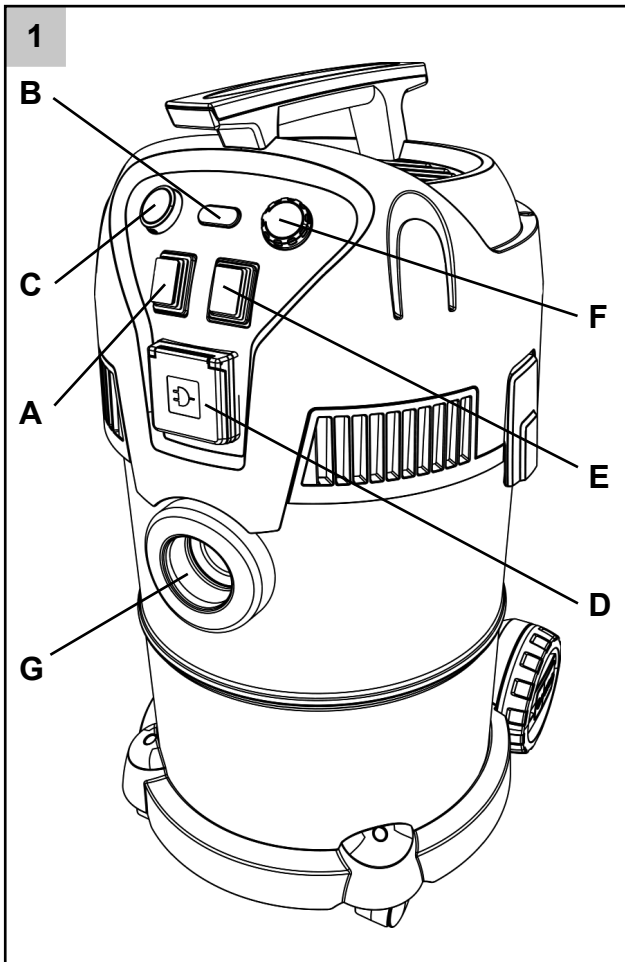

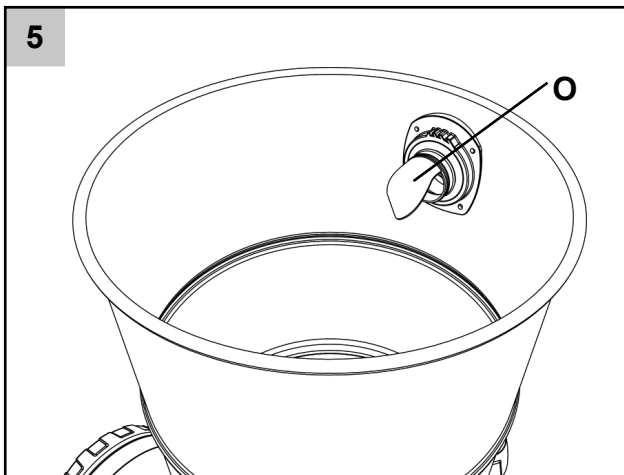
EN	Instructions for use	6 - 10
DE	Betriebsanleitung.....	11 - 16
FR	Instructions d'utilisation	17 - 22
NL	Gebruiksaanwijzing	23 - 28
IT	Istruzioni sull'uso	29 - 34
NO	Instruksjonsbok.....	35 - 39
SV	Bruksanvisning	40 - 44
DA	Brugsvejledning.....	45 - 49
FI	Käyttöohje.....	50 - 54
ES	Instrucciones de manejo.....	55 - 59
PT	Instruções de operação	60 - 65
EL	Οδηγίες χρήσης.....	66 - 71
TR	Kullanım Kılavuzu.....	72 - 79
SL	Priručnik za korisnike	80 - 84
HR	Navodila za uporabo.....	85 - 89
SK	Návod na používanie.....	90 - 94
CS	Návod k obsluze	95 - 99
PL	Instrukcja obsługi.....	100 - 105
HU	Használati útmutató.....	106 - 111
RO	Instrucțiuni de utilizare.....	112 - 117
BG	Инструкции за работа	118 - 123
RU	Руководство	124 - 129
ET	Kasutamishend	130 - 134
LV	Lietošanas instrukcijae	135 - 139
LT	Naudojimosi instrukcija.....	140 - 144
JA	取扱説明書.....	145 - 150

- EN
- DE
- FR
- NL
- IT
- NO
- SV
- DA
- FI
- ES
- PT
- EL
- TR
- SL
- HR
- SK
- CS
- PL
- HU
- RO
- BG
- RU
- ET
- LV
- LT
- JA

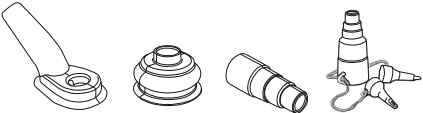

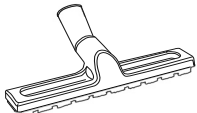

Optional accessories - Optionales Zubehör - Accessoires en option - Optionele accessoires - Accessori opzionali - Valgfritt tilbehør - Valfria tillbehör - Ekstra tilbehør - Accesorios opcionales - Acessórios opcionais - Προαιρετικά εξαρτήματα - İsteğe bağlı aksesuarlar - Dodatna oprema - Opcijski pribor - Doplnkové príslušenstvo - Voliteľné príslušenství - Opcionális kiegészítők - Accesorii opționale - Acessórios opcionais - Lisävarusteet - Opcjonalne akcesoria - Допълнителни принадлежности - Дополнительные принадлежности - Valikulised tarvikud - Papildu piederumi - Atskirai užsakomi priedai - オプションアクセサリー - الملحقات الاختيارية

107417190	Premium car kit	
107417191	Convenience kit	
107417192	Suction hose 2.5 m, 1 pcs.	
107417193	Suction hose 4 m, 1 pcs.	
107417194	Filter kit, 1 pcs.	
107417195	Dust bag fleece 22 l / 30 l, 4 pcs.	
107417196	Dust bag fleece 50 l, 4 pcs.	
107417197	Floor nozzle D 36 W/D 1, 1 pcs.	

EN

Dear Nilfisk customer

Congratulations on the purchase of your new Nilfisk vacuum cleaner.

Prior to using the appliance for the first time, be sure to read this document through and keep it ready to hand.

DE

FR

NL

IT

NO

SV

DA

FI

ES

PT

EL

TR

SL

HR

SK

CS

PL

HU

RO

BG

RU

ET

LV

LT

JA

Purpose and intended use

The vacuum cleaner is suitable for private use, e.g. for household, hobby workshops, car cleaning - sucking up non-hazardous dust and non-flammable liquids.

Symbols used to mark instructions**WARNING**

Danger that can lead to serious injuries and damage.

Important warnings**WARNING**

- No changes to the mechanical, electrical or thermal safety devices must be made.
- This appliance can be used by children aged from 8 years and above and persons with reduced physical, sensory or mental capabilities or lack of experience and knowledge if they have been given supervision or instruction concerning use of the appliance in a safe way and understand the hazards involved.
- Children shall be supervised to make sure that

they do not play with the appliance.

- Cleaning and user maintenance shall not be made by children without supervision.
- Never spray water on the upper section of the vacuum cleaner. Danger for persons, risk or short-circuiting.
- Never use the vacuum cleaner if the filter is not installed or if damaged.
- The vacuum cleaner features a blow function. Do not blow the air out in the open space. Only use the blow function with a clean tube. Dust may be harmful to health.

Hazardous materials**WARNING**

Vacuuming up hazardous materials can lead to serious or even fatal injuries. The following materials must not be picked up by the vacuum cleaner:

- hazardous dust
- hot materials (burning cigarettes, hot ashes etc.)
- flammable, explosive, aggressive liquids (e.g. petrol, solvents, acids, alkalis, etc.)

- flammable, explosive dust (e.g. magnesium or aluminium dust etc.)

Electrical connection

WARNING



- Before using the vacuum cleaner make sure that the voltage shown on the rating plate of the vacuum cleaner corresponds to the voltage of the local mains power supply.
- It is recommended that the vacuum cleaner should be connected via a residual current circuit breaker.
- The vacuum cleaner must not be used if the electrical cable or plug shows any sign of damage. Regularly inspect the cable and the plug for damage. If the power cord is damaged, it must be replaced by Nilfisk Service or an electrician to avoid danger before use of the vacuum cleaner is continued.
- Do not handle the electrical cable or plug with wet hands.
- Do not unplug by pulling on cable. To unplug, grasp the plug, not the cable. The plug must always be removed from the socket

outlet before starting any service or repair work of the machine or cable.

Maintenance

Always remove the electric plug from the socket before carrying out maintenance work on the machine.

Recycling the vacuum cleaner



The packaging materials can be recycled. Please recycle the components instead of throwing them in your household rubbish. You can also leave the packaging directly at your Nilfisk location to be properly recycled from there.

As specified in WEEE Directive 2012/19/EC on old electrical and electronic appliances, used electrical goods must be collected separately and recycled ecologically. Contact your local authorities or your nearest dealer for further information.

Warranty

Nilfisk guarantees vacuum cleaners for domestic use for 2 years. If your vacuum cleaner or accessories is/are handed in for repair, a copy of the receipt must be enclosed.

Guarantee repairs are being made on the following conditions:

- that defects are attributable to flaws or defects in materials or workmanship. (wear and tear as well as misuse are not covered by the guarantee).
- that the directions of this instruction manual have been thoroughly observed.
- that repair has not been carried out or attempted by other than Nilfisk-trained service staff.
- that only original accessories have been applied.
- that the product has not been exposed to abuse such as knocks, bumps or frost.
- that the vacuum cleaner has not been used for rental nor used commercially in any other way.

Batteries, lamps and wearing parts are excluded from the warranty.

In the event of defects arising during the duration of the warranty and of which Nilfisk is given notice, Nilfisk will, of their own choice, either repair the defects, replace the unit or refund the purchase price upon return of the unit. Opening the unit housing causes the warranty to become void. Further claims may not be made on the basis of the warranty. The statutory

EN

DE

FR

NL

IT

NO

SV

DA

FI

ES

PT

EL

TR

SL

HR

SK

CS

PL

HU

RO

BG

RU

ET

LV

LT

JA

EN

warranty rights of the customer remain unaffected. Manufacturer warranty claims shall be made to the manufacturer. Statutory warranty rights also remain unaffected in this case.

DE

FR

Picking up liquids

Before liquids are picked up, always remove the dust bag. Make sure the machine is equipped with a filter appropriate for wet suction. Check that the float works properly. If foam develops or liquid emerges from the machine, stop work immediately and empty the dirt tank.

NL

IT

NO

SV

Connecting electrical appliances

Use the socket on the vacuum cleaner for the purpose defined in the operating instructions only. Before plugging an appliance into the appliance socket:

1. Switch off the vacuum cleaner.
2. Switch off the appliance to be connected.

CAUTION! Follow the operating instructions and safety instructions for appliances connected to the power tool socket. Always unwind the cable of the vacuum cleaner completely before use.

DA

FI

ES

PT

EL

TR

The power consumption of the connected appliance

SL

Technical specifications

Model	Multi 22	Multi 22 Inox	Multi 22 T	Multi 22 T Inox	Multi 30 T	Multi 30 T Inox VSC	Multi 50 Inox
Region/country	EU, UK, ZA, AUS	EU, UK, ZA, AUS	UK	AUS/NZ	EU, UK, FR/BE/PL/ CZ, ZA, AUS	EU, UK, FR/BE/PL/ CZ, ZA, AUS	EU, UK, ZA, AUS
Container material	PP	INOX	PP	INOX	PP	INOX	INOX
Voltage (V)	220 - 240	220 - 240	220 - 240	220 - 240	220 - 240	220 - 240	220 - 240
P _{NOM} (W)	1130	1130	1130	1130	1260	1260	1260
P _{max} (W)	1200	1200	1200	1200	1400	1400	1400
Max Vacuum, kPa/bar	20/200	20/200	20/200	20/200	21/210	21/210	21/210
Max Suction power - machine, W	270	270	270	270	292	292	292
Sound power (EN 60704-2-1), dB(A)	85	85	85	85	87	87	87
Tank size, L	22	22	22	22	30	30	50
Net filling dry, in bag, L	9	9	9	9	13	13	20
Net filling liquid, L	14	14	14	14	20	20	36
Filter indicator	yes	yes	yes	yes	yes	yes	yes
Push to Clean		yes	yes	yes	yes	yes	yes
Power out, max 1150 W			yes	yes	yes	yes	
Auto on/off			yes	yes	yes	yes	
Variable suction control						yes	

must never exceed the value stated on the type plate of the vacuum cleaner - power consumption max 1150 W.

The operating voltage shown on the rating plate must correspond to the voltage of the mains power supply.

Parts identification (ref. illu. 1&2, page 4)

- A. Button for automatic on/off switch for attached power tool (auto on/off) *
- B. Filter cleaning indicator
- C. Button for "Push to Clean"-function *
- D. Power outlet
- E. On/off switch
- F. Variable suction controller *
- G. Connection for hose when vacuuming
- H. Connection for hose when blowing
- I. Handle bar (& storage of power cord)
- J. Quick park position (female)
- K. Storage options for tubes, nozzles and accessories
- L. Storage option for tube and accessories
- M. Tensioning plate for filter
- N. Filter
- O. Dust bag mounting

* Varies depending on model.

HR

SK

CS

PL

HU

RO

BG

RU

ET

LV

LT

JA

Operational instructions

Using the vacuum cleaner

On/Off - position "E"

Switch "0-I"

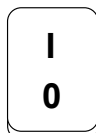
	Switch position	Function
	I	On
	0	Off

Powertool Auto On/Off - position "A"

Switch "0-I"

	Switch position	Function
	I	On
	0	Off

The machine provides two modes of operation: vacuuming and blowing.

When using the machine for vacuuming, the hose is connected to "G". When using the machine for blowing, the hose is connected to "H".

The machine is turned on or off at switch "E".

When running and operational the light in "B" will not light. The light "B" will light when a drop in suction performance occurs due to a dirty filter.

Cleaning the filter with Push to Clean*)

If the light "B" is turned on, the filter may be clogged.

1. Hold one hand against the end of the hose to form a closed wall. Push the "Push to Clean" button "C" for 2-3 seconds to let the machine clean the filter. Wait for 3-5 seconds and repeat Step 1, max. 3 times.
2. If the indicator still lights, the cause may lie in a too heavily clogged filter. Occasionally a light rinse is sufficient. If not, then replace the filter by a new one.

Filter change (ref. illu. 4, page 4)

1. Open the machine so the filter is accessible.
2. Unscrew the tensioning plate "M" to release the filter.
3. Remove the filter and replace it by a new one.
4. Tighten tensioning plate (turn right). Make sure the threads on the tensioning plate are aligned properly with the threads on the machine. Tighten the tensioning plate firmly so the filter seals make a closed connection to the machine. Beware not to over-tighten the tensioning plate.

5. Assemble the machine again making sure the motor head has a proper fit to the container.

Dust bag change

1. Open the machine so the dust bag is accessible.
2. Remove the old dust bag.
3. Gently slide the new dust bag over the angled tube "O" and place the lip of the dust bag firmly in the groove.
4. Assemble the machine again making sure the motor head has a proper fit to the container.

Using the machine to clean up liquids

Prepare for use

1. Open the machine so the dust bag is accessible.
2. Remove the dust bag.
3. Assemble the machine again making sure the motor head has a proper fit to the container.

Empty for liquids

1. Make sure the liquid in the hose has entered the container to avoid spilling dirty water.
2. Disconnect the hose from the machine.
3. Open the machine and make container accessible alone.
4. Empty the machine over the backside or the sides to prevent dirty water to slip out of the hose connection.
5. Assemble the machine again making sure the motor head has a proper fit to the container.

Storage

1. Make sure the hose is emptied for dust or dirt and the material has entered the container.
2. Remove the electric cable from power supply.
3. The cable may be stored by rolling it around the handle bar.
4. Place tubes and nozzles in Accessory storage areas "K" or in quick park position "J".
5. Wind hose around machine and use hose hook to get a grip of the hose.

EN

DE

FR

NL

IT

NO

SV

DA

FI

ES

PT

EL

TR

SL

HR

SK

CS

PL

HU

RO

BG

RU

ET

LV

LT

JA

EN

Declaration of Conformity

DE

We,
 Nilfisk A/S
 Kornmarksvej 1
 DK-2605 Broendby
 DENMARK

FR

NL

IT

Hereby declare that the

NO

Product: VAC - Consumer - Wet/Dry
 Description: 220-240V, 50/60 Hz, IP24
 Type: Multi II 22*, 30*, 50*

SV

Is in compliance with the following standards:

DA

EN 60335-1:2012+A11:2014
 EN 60335-2-2:2010+A11:2012+A1:2013
 EN 55014-1:2006+A1:2009+A2:2011
 EN 55014-2:2015
 EN 61000-3-2:2014
 EN 61000-3-3:2013
 EN 50581:2012

FI

ES

PT

EL

Following the provisions of:

TR

2014/35/EU
 2014/30/EU
 2011/65/EC
 2009/125/EC

SL

HR

Hadsund, 04-10-2017

SK

CS

 Esben Graff
 VP Portfolio Management, Consumer

PL

HU

RO

BG

RU

ET

LV

LT

JA



HEAD QUARTER

DENMARK

Nilfisk A/S
Kornmarksvej 1
DK-2605 Broendby
Tel.: (+45) 4323 8100
Website: www.nilfisk.com

SALES COMPANIES

ARGENTINA

Nilfisk srl.
Edificio Central Park
Herrera 1855, 6th floor/604
Ciudad de Buenos Aires
Tel.: (+54) 11 6091 1571
Website: www.consumer.nilfisk.com.ar

AUSTRALIA

Nilfisk Pty Ltd
Unit 1/13 Bessemer Street
Blacktown NSW 2148
Tel.: (+61) 2 98348100
Website: www.consumer.nilfisk.com.au

AUSTRIA

Nilfisk GmbH
Metzgerstrasse 68
5101 Bergheim bei Salzburg
Tel.: (+43) 662 456 400 90
Website: www.nilfisk.at

BELGIUM

Nilfisk n.v.s.a.
Riverside Business Park
Boulevard Internationalelaan 55
Bâtiment C3/C4 Gebouw
Bruxelles 1070
Tel.: (+32) 24 67 60 50
Website: www.consumer.nilfisk.be

Brazil

Nilfisk do Brasil
Av. Eng. Luis Carlos Berrini, 550
40 Andar, Sala 03
SP - 04571-000 Sao Paulo
Tel.: (+11) 3959-0300 / 3945-4744
Website: www.nilfisk.com.br

CANADA

Nilfisk Canada Company
240 Superior Boulevard
Mississauga, Ontario L5T 2L2
Tel.: (+1) 800-668-8400
Website: www.nilfisk.ca

CHILE

Nilfisk S.A. (Comercial KCS Ltda)
Salar de Llamara 822
8320000 Santiago
Tel.: (+56) 2684 5000
Website: www.nilfisk.cl

CHINA

Nilfisk
4189 Yindu Road
Xinzhuang Industrial Park
201108 Shanghai
Tel.: (+86) 21 3323 2000
Website: www.nilfisk.cn

CZECH REPUBLIC

Nilfisk s.r.o.
VGP Park Horní Počernice
Do Čertous 1/2658
193 00 Praha 9
Tel.: (+420) 244 090 912
Website: www.consumer.nilfisk.cz

DENMARK

Nilfisk Danmark A/S
Industrivej 1
Hadsund, DK-9560
Tel.: 72 18 21 20
Website: www.consumer.nilfisk.dk

FINLAND

Nilfisk Oy Ab
Koskelontie 23 E
02920 Espoo
Tel.: (+358) 207 890 600
Website: www.consumer.nilfisk.fi

FRANCE

Nilfisk SAS
26 Avenue de la Baltique
Villebon sur Yvette
91978 Courtaboeuf Cedex
Tel.: (+33) 169 59 87 24
Website: www.consumer.nilfisk.fr

GERMANY

Nilfisk GmbH
Guido-Oberdorfer-Straße 2-10
89287 Bellenberg
Tel.: (+49) (0)7306/72-444
Website: www.consumer.nilfisk.de

GREECE

Nilfisk A.E.
Αναπαύσεως 29
Κορωπί T.K. 194 00
Tel.: (30) 210 9119 600

Website: www.consumer.nilfisk.gr

HOLLAND

Nilfisk B.V.
Versterkerstraat 5
1322 AN Almere
Tel.: (+31) 036 5460760
Website: www.consumer.nilfisk.nl

HONG KONG

Nilfisk Ltd.
2001 HK Worsted Mills
Industrial Building
31-39, Wo Tong Tsui St.
Kwai Chung, N.T.
Tel.: (+852) 2427 5951
Website: www.nilfisk.com

HUNGARY

Nilfisk Kft.
II. Rákóczi Ferenc út 10
2310 Szigetszentmiklós-Lakihegy
Tel.: (+36) 24 475 550
Website: www.nilfisk.hu

INDIA

Nilfisk India Limited
Pramukh Plaza, 'B' Wing, 4th floor, Unit No. 403
Cardinal Gracious Road, Chakala
Andheri (East) Mumbai 400 099
Tel.: (+91) 22 6118 8188
Website: www.nilfisk.in

IRELAND

Nilfisk
1 Stokes Place
St. Stephen's Green
Dublin 2
Tel.: (+35) 3 12 94 38 38
Website: www.nilfisk.ie

ITALY

Nilfisk SpA
Strada Comunale della Braglia, 18
26862 Guardamiglio (LO)
Tel.: (+39) (0) 377 414021
Website: www.nilfisk.it

JAPAN

Nilfisk Inc.
1-6-6 Kita-shinyokohama, Kouhoku-ku
Yokohama, 223-0059
Tel.: (+81) 45548 2571
Website: www.nilfisk.com

MALAYSIA

Nilfisk Sdn Bhd
Sd 33, Jalan KIP 10
Taman Perindustrian KIP
Sri Damansara
52200 Kuala Lumpur
Tel.: +603 6275 3120
Website: www.nilfisk.com

MEXICO

Nilfisk de Mexico, S. de R.L. de C.V.
Pirineos #515 Int.
60-70 Microparque
Industrial WSantiago
76120 Queretaro
Tel.: (+52) (442) 427 77 00
Website: www.nilfisk.com

NEW ZEALAND

Nilfisk Limited
Suite F, Building E
42 Tawa Drive
0632 Albany Auckland
Tel.: (+64) 9 414 1996
Website: www.nilfisk.com

NORWAY

Nilfisk AS
Bjørnerudveien 24
1266 Oslo
Tel.: (+47) 22 75 17 80
Website: www.consumer.nilfisk.no

PERU

Nilfisk S.A.C.
Calle Boulevard 162, Of. 703, Lima 33- Perú
Lima
Tel.: (511) 435-6840
Website: www.nilfisk.com

POLAND

Nilfisk Sp. Z.O.O.
Millenium Logistic Park
ul. 3 Maja 8, Bud. B4
05-800 Pruszków
Tel.: (+48) 22 738 3750
Website: www.consumer.nilfisk.pl

PORTUGAL

Nilfisk Lda.
Sintra Business Park
Zona Industrial Da Abrunheira
Edifício 1, 1º A
P2710-089 Sintra
Tel.: (+351) 21 911 2670
Website: www.nilfisk.pt

RUSSIA

Nilfisk LLC
Vyatskaya str. 27, bld. 7/1st

127015 Moscow
Tel.: (+7) 495 783 9602
Website: www.consumer.nilfisk.ru

SINGAPORE

Den-Sin
22 Tuas Avenue 2
639453 Singapore
Tel.: (+65) 6268 1006
Website: www.densin.com

SLOVAKIA

Nilfisk s.r.o.
Bancikovej 1/A
SK-821 03 Bratislava
Tel.: (+421) 910 222 928
Website: www.consumer.nilfisk.sk

SOUTH AFRICA

Nilfisk (Pty) Ltd
Kimbult Office Park, 9 Zeiss Road
Laser Park, Honeydew
Johannesburg
Tel.: (+27) 118014600
Website: www.nilfisk.co.za

SOUTH KOREA

Nilfisk Korea
3F Duksoo B/D, 317-15
Sungsoo-Dong 2Ga
Sungdong-Gu, Seoul
Tel.: (+82) 2497 8636
Website: www.nilfisk.co.kr

SPAIN

Nilfisk S.A.U
Paseo del Rengle, 5 Planta. 9-10
08302 Mataró
Tel.: (34) 93 741 2400
Website: www.consumer.nilfisk.es

SWEDEN

Nilfisk AB
Taljegårdsgatan 4
431 53 Mölndal
Tel.: (+46) 31 706 73 00
Website: www.consumer.nilfisk.se

SWITZERLAND

Nilfisk AG
Ringstrasse 19
Kircheberg/Industri Stelz
9500 Wül
Tel.: (+41) 71 92 38 444
Website: www.consumer.nilfisk.ch

TAIWAN

Nilfisk Ltd
Taiwan Branch (H.K)
No. 5, Wan Fang Road
Taipei
Tel.: (+88) 6227 00 22 68
Website: www.nilfisk.tw

THAILAND

Nilfisk Co. Ltd.
89 Soi Choekchai-Ruammitr
Viphavadee-Rangsit Road
Ladyao, Jatuchak, Bangkok 10900
Tel.: (+66) 2275 5630
Website: www.nilfisk.co.th

TURKEY

Nilfisk A.S.
Serifali Mh. Bayraktar Bulv. Sehit Sk. No:7
Umraniye, 34775 Istanbul
Tel.: +90 216 466 94 94
Website: www.consumer.nilfisk.com.tr

UNITED ARAB EMIRATES

Nilfisk Middle East Branch
SAIF-Zone
P.O. Box 122298
Sharjah
Tel.: (+971) (0) 655-78813
Website: www.nilfisk.com

UNITED KINGDOM

Nilfisk Ltd.
Nilfisk House, Bowerbank Way
Gilwilly Industrial Estate, Penrith
Cumbria CA11 9BQ
Tel.: (+44) (0) 1768 868995
Website: www.consumer.nilfisk.co.uk

UNITED STATES

Nilfisk Inc.
14600 21st Avenue North
Plymouth, MN-55447
Tel.: (+1) 800-989-2235
Website: www.nilfisk.com

VIETNAM

Nilfisk Vietnam
No. 51 Doc Ngu Str.
P. Vinh Phúc, Q.Ba Dinh
Hanoi
Tel.: (+84) 761 5642
Website: www.nilfisk.com